

CODE NUMBER

3080242

DESCRIPTION

1.6 gpf, Polished Chrome Finish, Single Flush, Regal® Exposed Manual Water Closet Flushometer.

DETAILS

- Flush Volume: 1.6 gpf (6.0 Lpf)
- Finish: Polished Chrome (CP)
- Valve: Diaphragm
- Valve Body Material: Semi-red Brass
- Fixture Type: Water Closet
- Fixture Connection: Top spud
- Rough-In Dimension: 16" (406mm)
- Spud Coupling: 1 ½" (38mm)
- Supply Pipe: 1" (25mm)

FEATURES

- ADA Compliant Metal Oscillating Non-Hold-Open Handle
- 1" I.P.S. Screwdriver Bak-Chek® Angle Stop
- Control Stop Plug
- Sweat Solder Adapter with Cover Tube
- Cast Wall Flange with Set Screw
- Vacuum Breaker Flush Connection
- Spud Coupling and Spud Flange for 1½" Top Spud
- Non-Hold-Open Handle and No External Volume Adjustment to Ensure Water Conservation
- Diaphragm, Handle Packing and Vacuum Breaker Molded from PERMEX® Rubber Compound for Chloramine Resistance

**COMPLIANCES & CERTIFICATIONS**

(ADA Compliant, cUPC Certified, BAA Compliant)

RECOMMENDED SPECIFICATION

Valve Body, Cover, Tailpiece and Control Stop shall be in conformance with ASTM Alloy Classification for Semi- Red Brass. Valve shall be in compliance with the applicable sections of ASSE 1037 and ANSI/ASME 112.19.2.

VALVE OPERATING PRESSURE (FLOWING)

15–80 PSI (103–552 kPa). Specific fixtures may require greater minimum flowing pressure - consult manufacturer requirements.

DOWNLOADS

- [Regal XL Exposed Installation Instructions](#)
- [Control Stop Repair and Maintenance Guide](#)
- [Flush Connections Flanges Repair and Maintenance Guide](#)
- [Tail Piece Repair and Maintenance Guide](#)
- [Regal Flushometers Repair and Maintenance Guide](#)
- [Additional Downloads](#)

NOTES

All information contained within this document subject to change without notice.

Looking for other variations of the REGAL 113 product? [View the general spec sheet with all options.](#)

[Find a compatible urinal](#) for this flushometer.

[Find a compatible water closet](#) for this flushometer.

Sloan 10500 Seymour Ave, Franklin Park, IL 60131

Phone: 800.982.5839 • Fax: 800.447.8329 • sloan.com

ROUGH-IN

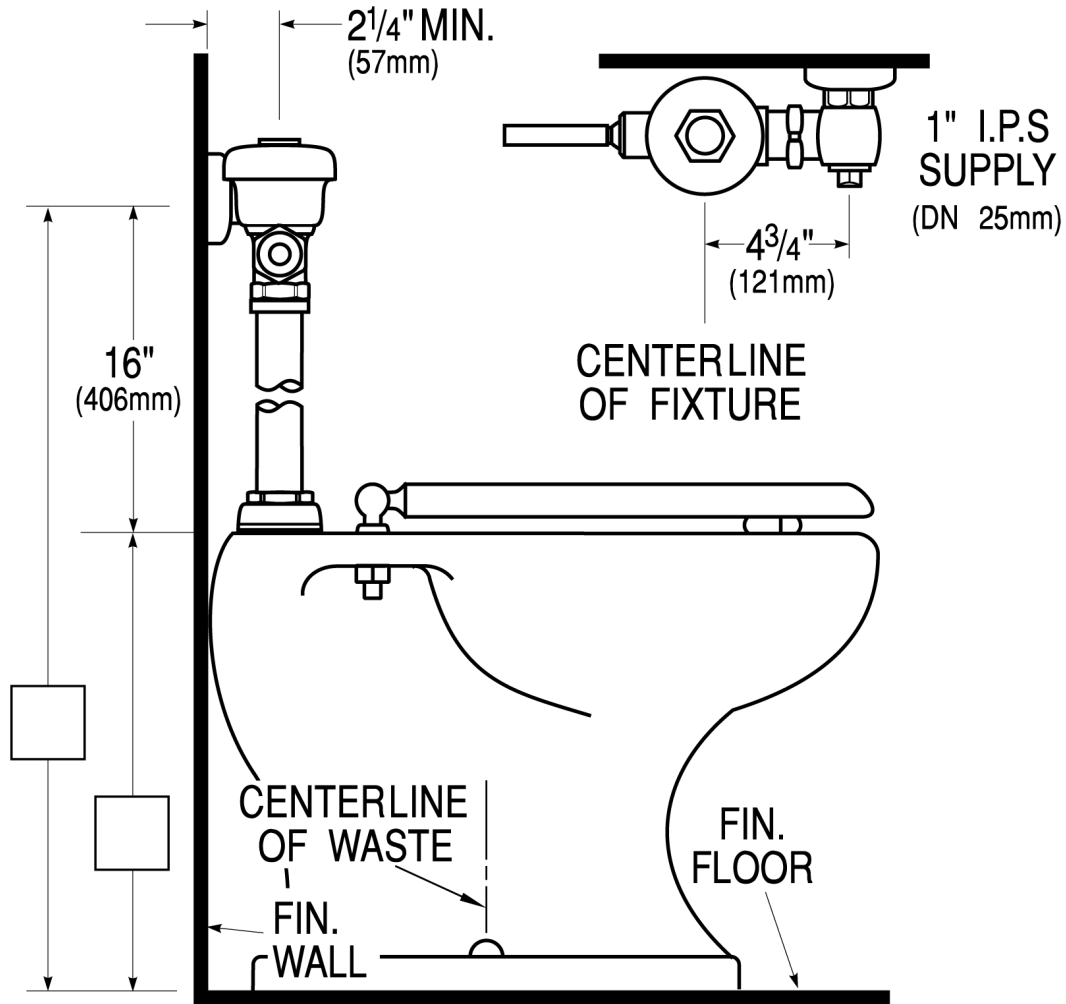

Sloan 10500 Seymour Ave, Franklin Park, IL 60131
Phone: 800.982.5839 • Fax: 800.447.8329 • sloan.com