

Tools:



Adjustable Wrench Plumbers Putty Sealant Tape Rags

Warnings and Notes:

Check with local plumbing code requirements before installation. This product should be installed by a local listed plumber. **Do not use plumbers putty on threads.**



Installation Steps:

Two Handle Lavatory Widespread Faucet

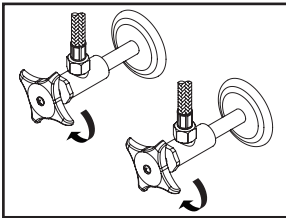

(1) Shut off the water supply. Remove old faucet. Clean mounting surface in preparation for new faucet.

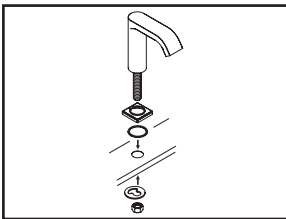

(2) Make sure gasket is under spout. Place spout in position on the sink, slide mounting bracket through spout shank from underneath the sink, thread mounting nut onto spout shank and tighten the mounting nut.

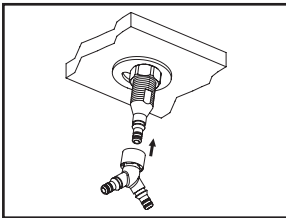

(3a) For 2247-L, Insert Y connector into the end of quick connect adaptor on the inlet end of the spout shank. Push until a "click" sound is heard. Pull down the Y connector to test engagement.

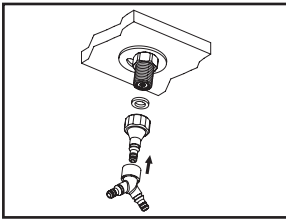

(3b) For 2947-L, with washer inside, thread and tighten quick connect adaptor to spout shank then insert Y connector into the end of quick connect adaptor on the inlet end of the spout shank. Push until a "click" sound is heard. Pull down the Y connector to test engagement.

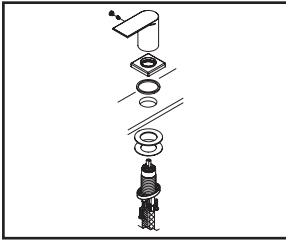

(4) Thread escutcheon with gasket from top of the side valve, attach handle to the side valve with help of 3/32" Allen wrench put hole cover on the handle. Place cold and hot side valves in position on the sink, ensure handles operate in correct direction. From underneath the sink, hand-tighten locknut to the side valve. Position side valve to desired location from top. Tighten screws on locknut with the help of Phillips head screwdriver to secure side valve.

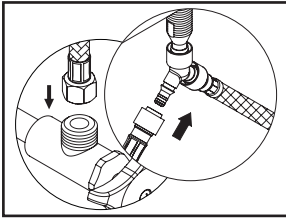

(5) Insert outlet hose of the side valve into the end of quick connect on the Y connector, push until a "click" sound is heard. Pull down the outlet hose of both side valves to test engagement.

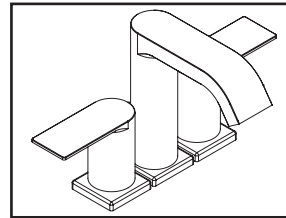

(6) Turn on the water and allow both hot and cold water to run for at least one minute each. While water is running, check for leaks. Turn off the water when finished.

Pop-Up Drain Installation:

"DO NOT USE THREAD SEALANTS, TEFLON TAPE ONLY"

"NO USE SELLADORES DE ROSCA, UTILIZAR SOLO CINTA DE TEFLON"

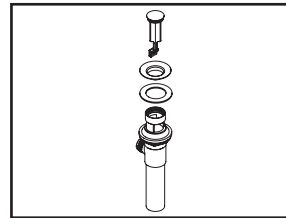

(1) Remove flange from drain body.

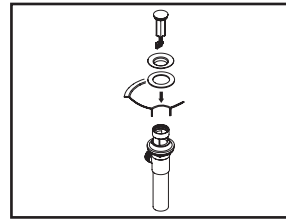

(2) Place a ring of plumbers putty on the bottom of the flange and apply Teflon tape on threaded tailpiece. Thread tailpiece to drain body. Insert flange through drain hole and attach drain body to flange from underneath the sink. **Please Note: Use Teflon tape only on all thread connection areas. Using pipe thread sealant might weaken material structure and cause leaks.**

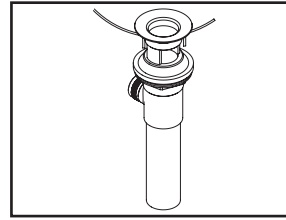

(3) Ensure the pivot rod hole on the pop-up body faces toward the back of the sink. Tighten the lock nut securely with a wrench.

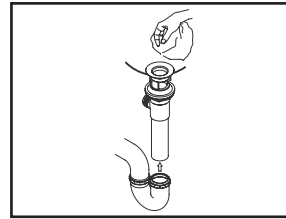

(4) Connect pop-up tail piece to the trap (check manufacturer's instruction for installation) and remove the excess plumbers putty.

Model Number: 2247-L, 2947-L

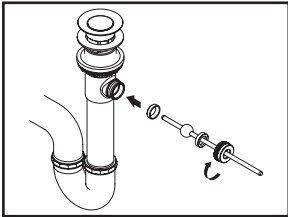

(5) Remove pivot rod nut from pop-up body and ensure the washer is in place. Insert pivot rod and tighten rod nut back to pop-up body.

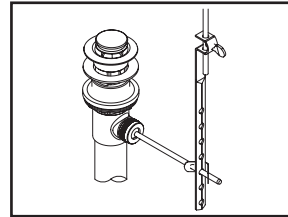

(7) Connect lift rod strap to pivot rod by using clip. Tighten thumbscrew to connect lift rod strap to pop-up lift rod.

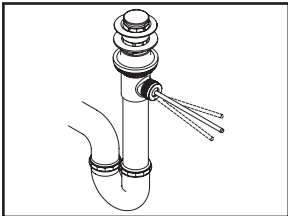

(6) Push pivot rod down and insert drain plug carefully. Test to ensure drain plug works properly.

EXPLODED DRAWING

Model Number: 2247-L

* Note: Please specify finish/color when ordering.

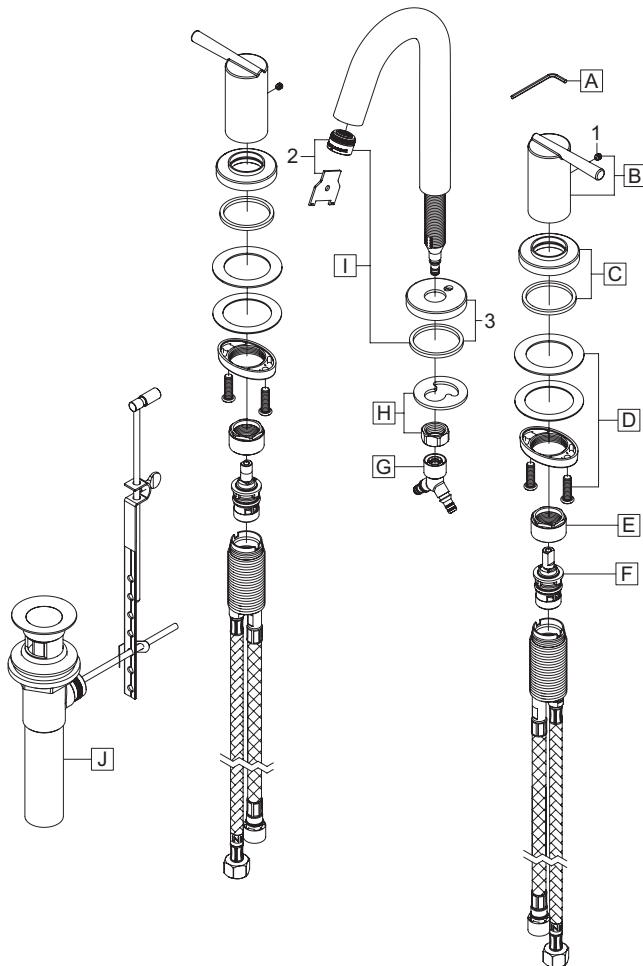

ITEM #	DESCRIPTION
A	OP-490011 3/32" Allen Wrench
B	OP-190016C, H* Lever Handle-Cold, Hot
C	OP-430036* Valve Escutcheon & Gasket
D	OP-530006 Valve Mounting Kit
E	OP-490006 Bonnet Nut
F	OP-330002C, H Ceramic Stem-Cold, Hot
G	X-4300101 'Y' Connector
H	OP-430001 Spout Mounting Kit
I	OP-230009* Gooseneck Style Spout
K	OP-630009* Brass Pop-Up Drain Assembly
1	OP-420047 3/32" Allen Screw
2	OP-490062* 1.2 GPM Aerator & Tool
3	OP-430037* Spout Escutcheon & Gasket

Model Number: 2947-L

* Note: Please specify finish/color when ordering.

	ITEM #	DESCRIPTION
A	OP-490011	3/32" Allen Wrench
B	OP-190017C, H*	Lever Handle-Cold, Hot
C	X-4300094*	Valve Escutcheon & Gasket
D	OP-530006	Valve Mounting Kit
E	OP-490006	Bonnet Nut
F	OP-330002C, H	Ceramic Stem-Cold, Hot
G	X-4300101	'Y' Connector
H	X-4300102	Quick Connect Adaptor
I	OP-430001	Spout Mounting Kit
J	OP-230010*	Spout
K	X-6300029*	Brass Pop-Up Drain Assembly
1	OP-490029	3/32" Allen Screw
2	X-4900044*	Hole Cover
3	OP-490069	Aerator
4	OP-420047	3/32" Allen Screw
5	OP-430043	1.2 GPM Restrictor
6	OP-430044*	Spout Escutcheon & Gasket

