

Model Number: 0205-K, 5205-K
052TM2, 062TM2

Tools:



Adjustable Wrench Phillips screwdriver Plumbers Putty Teflon Tape Rags

Warnings and Notes:

Check with local plumbing code requirements before installation.
This product should be installed by a local listed plumber.

Do not use plumbers putty on threads.



Installation Steps:

Single Handle Pull-Down Kitchen Faucet

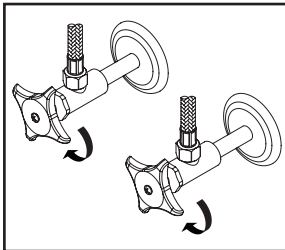

(1) Shut off the water supply. Remove old faucet. Clean mounting surface in preparation for new faucet.

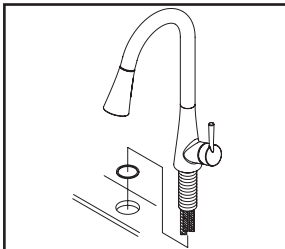

(2a) **For 1-Hole Installation:-** Ensure there is a washer under the faucet. Place the faucet in position on the sink.

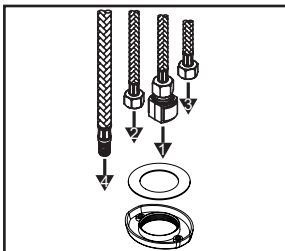

(2b) With flat side of the locknut facing down and the steel washer inside the locknut please follow the order as the drawing shows to insert flex hoses through the center hole of the locknut from underneath the sink.

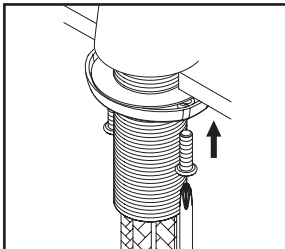

(2c) Thread locknut onto the faucet shank from underneath the sink. Position faucet to desired location from the top and hand-tighten locknut till it won't go further. Thread both screws on locknut and tighten screws on locknut with the help of a Phillips head screwdriver to secure faucet. (Note: Do not overtighten.)

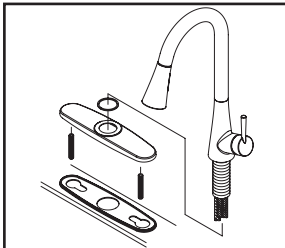

(3a) **For 3-Hole Installation:-** Thread mounting bolts to deck plate, apply plumbers putty under the base gasket, place faucet on the deck plate, make sure spout swivel angle are even to the right and to the left. Lead inlet & outlet flex hoses through center mounting hole to place faucet with deck plate and base gasket in position on the sink. Hand-tighten locknut to the faucet and tighten screws on locknut with the help of Phillips head screwdriver from underneath the sink.

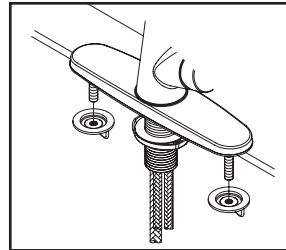

(3b) Thread and tighten both mounting nuts to mounting bolts from underneath the sink to secure faucet on the sink.

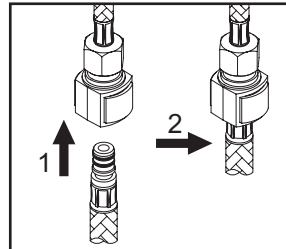

(4) Insert spray head hose into end of quick connect adapter on the outlet hose, push until a "click" is heard. Pull down to test engagement.

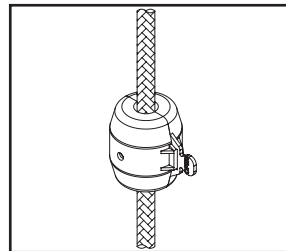

(5) Install weight on spray head hose. Adjust weight's position so the spray head can be retracted properly.

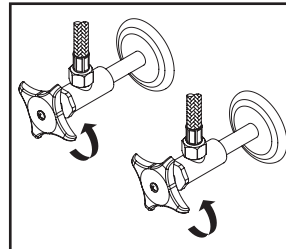

(6) Connect hot and cold inlet supply hoses to supply stops. For supply stop with 1/2" outlet connection, use 3/8" male to 1/2" female adapter for installation. Adapters are optional and are not provided with the faucet. Turn on both side supply stops to check any leaks.

Model Number: 0205-K, 5205-K

* Note: Please specify finish/color when ordering.

	ITEM #	DESCRIPTION
A	OP-420068*	1.5 GPM Spray Head (For 0205-K)
B	OP-420074	Spray Hose and O-ring (For 0205-K)
C	X-4200190	Spout Repair Kit
D	OP-390003	Ceramic Disc Cartridge
E	OP-420057	Retainer Nut
F	OP-420058*	Cap
G	OP-120004*	Lever Handle
H	OP-420059	Washer
I	X-4200199	Quick Connect
J	OP-520015	Locknut with Screws
K	OP-420070	Weight
L	OP-420045*	Deck Plate & Base Gasket
M	OP-520003	Mounting Bolts & Nuts
N	X-4200194*	1.5 GPM Spray Head (For 5205-K)
O	X-4200197	Spray Hose (For 5205-K)
P	X-4200178	Spray Head Support (For 5205-K)
1	OP-420060	O-Ring (For 0205-K)
2	OP-420061	Allen Screw
3	OP-420075	Washer (For 0205-K)

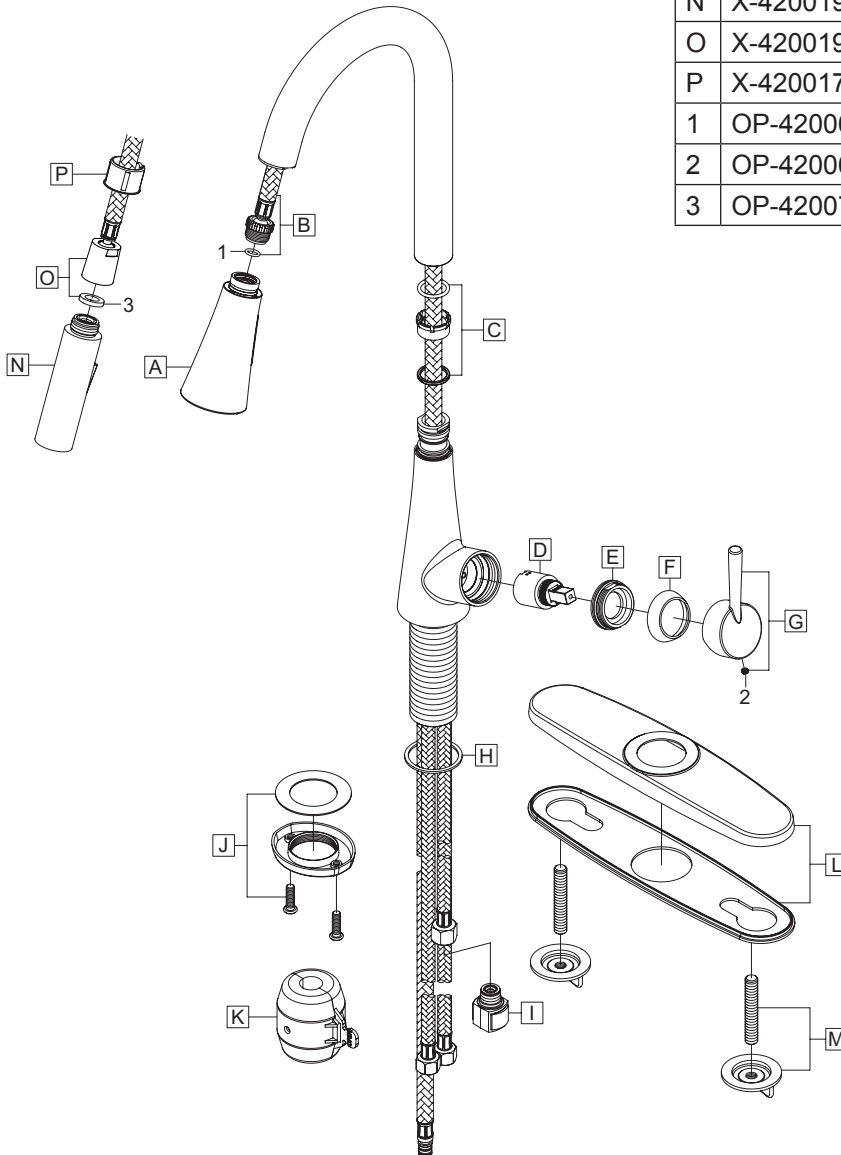

Model Number: 052TM2, 062TM2

* Note: Please specify finish/color when ordering.

	ITEM #	DESCRIPTION
A1	X-4200205*	1.5 GPM Spray Head (For 052TM2)
A2	X-4200194*	1.5 GPM Spray Head (For 062TM2)
B	X-4200197	Spray Hose
C	X-4200178	Spray Head Support
D	X-4200190	Spout Repair Kit
E	X-3900008	Ceramic Disc Cartridge
F	X-4200192	Retainer Nut
G	X-4400032*	Cap
H	X-1200024*	Lever Handle
I	X-4200199	Quick Connect
J	OP-520015	Locknut with Screws
K	OP-420070	Weight
L	X-4200075*	Deck Plate & Base Gasket
M1	X-4200074*	Escutcheon & Gasket (For 052TM2)
M2	X-4200187	Gasket (For 062TM2)
1	X-4400024	Allen Screw
2	X-4900044*	Hole Cover
3	OP-420075	Washer

