

CSSD28 INSTALL GUIDE

DIMENSIONAL RENDERINGS

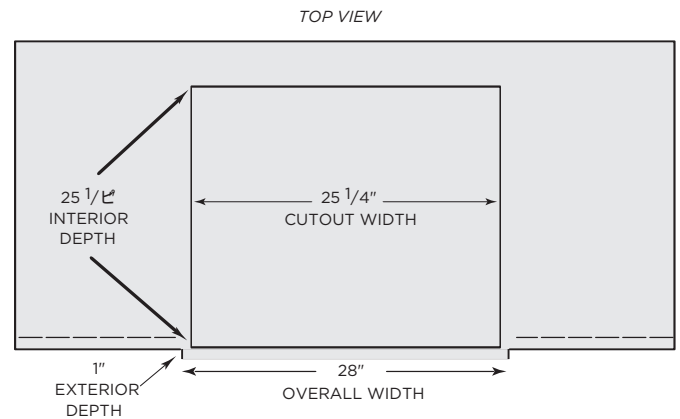
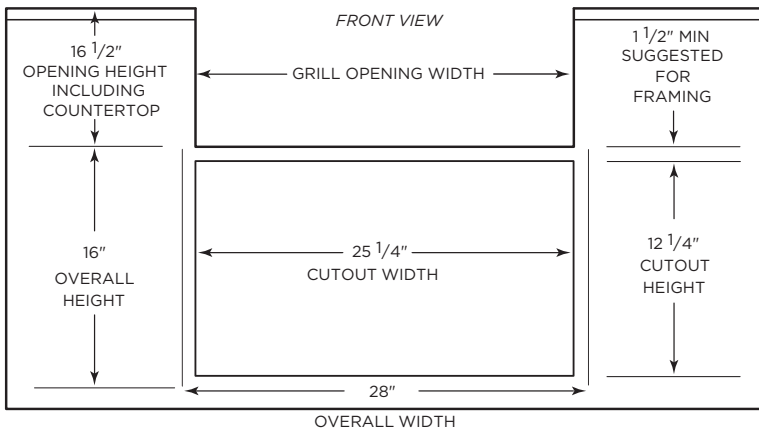
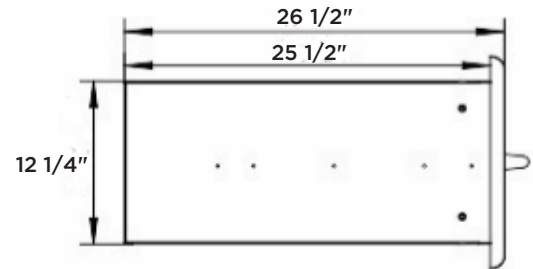
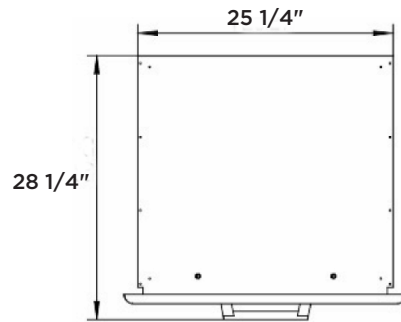
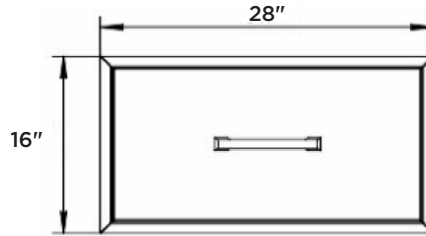
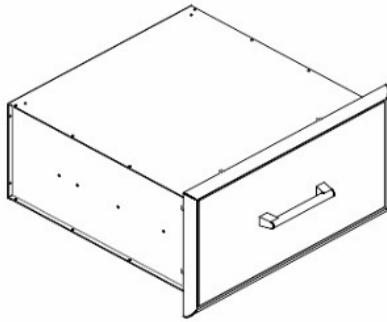

Overall Product Dimensions			
Model No.	Height	Width	Depth
CSSD28	16"	28"	26 1/2"

Cutout Dimensions for Island			
Model No.	Height	Width	Depth
CSSD28	12 1/4"	25 1/4"	25 1/2"

Install Notes:

- ✓ The drawer has a gasket to keep moisture out and is capable of holding 80 lbs
- ✓ 2 anchor points are located on each side of the doors interior frame (top, bottom, left and right)
- ✓ Due to wide variance of possible building materials, anchors are not included
- ✓ When inserting your anchors be sure to use a framing square to ensure the door is not pulled out of square
- ✓ Additional framing and/or support underneath the rear (hanging portion) of the cabinet is recommended
- ✓ These specs are accurate but we always suggest having the product physically on site to ensure full understanding of how this product will coordinate with your build