



INSTALLATION GUIDE AND OWNER'S MANUAL

KwickShot® Tankless Electric Water Heaters



BEFORE ATTEMPTING ANY INSTALLATION, MODIFICATION OR SERVICE OF THE HEATER, MAKE SURE THE ELECTRICAL POWER IS DISCONNECTED.

Read and understand the instructions thoroughly before attempting the installation or service of the water heater. Failure to follow the instructions can result in serious injury, death and/or property damage. The warranty of the water heater will depend upon proper installation according to the instructions. Some heaters come supplied with separate faucet aerators. If supplied, the aerator must be installed in the faucet for optimum performance. The heater must only be used to heat water and must be installed in a location where it is not subject to freezing temperatures. The manufacturer is not liable for any damages resulting from improper installation or misuse.

The installation must conform to the latest requirements of the National Electrical Code and all applicable state and local codes. This information is available through local authorities. You must fully understand the requirements before beginning this installation.

This water heater is not required by UL 499 to employ a temperature and pressure relief valve (T&P). Check with local codes to find out if one is required. If it is, the T&P valve must be installed in the outlet hot water pipe between the heater and the isolation valve.

IMPORTANT SAFETY INSTRUCTIONS

When using electrical equipment, basic safety precautions should always be followed, including the following:

READ AND FOLLOW ALL INSTRUCTIONS

Supply the water heater only from a grounded system. A green terminal (or a wire connector marked "G", "GR", "Ground", or "GROUNDING") is provided for wiring the appliance. To reduce the risk of electric shock, connect this terminal, or connector, to the grounding terminal of the electric service or supply panel with a continuous copper wire. Connection should be made in accordance with the electrical installation code.

Contents

1. GENERAL	2
2. MOUNTING THE UNIT TO THE WALL	3
3. PLUMBING HOOK-UP	4
4. ELECTRICAL HOOK-UP	7
5. COMMISSIONING THE HEATER	9
6. THERMOSTATIC UNIT OPERATION	11
7. TROUBLESHOOTING	13
8. PERIODIC MAINTENANCE	15
9. REPLACEMENT PART NUMBERS	15
10. REPAIR PARTS	16

⚠ CAUTION DO NOT INSTALL IN A BATH ENCLOSURE OR SHOWER STALL OR CONNECT TO A SALT-REGENERATED WATER SOFTENER OR A WATER SUPPLY OF SALT WATER. ATTENTION: NE PAS INSTALLER DANS UNE BAIGNOIRE OU UNE CABINE DE DOUCHE ET NE PAS BRANCHER À UN ADOUCISSEUR D'EAU RÉGÉNÉRÉ AVEC DU SEL OU À UN APPROVISIONNEMENT EN EAU SALÉE.

⚠ CAUTION (CANADIAN INSTALLATIONS ONLY) CONNECT ONLY TO A CIRCUIT PROTECTED BY A CLASS A GROUND FAULT CIRCUIT INTERRUPTER. ATTENTION: BRANCHER UNIQUEMENT À UN CIRCUIT PROTÉGÉ PAR UN DISJONCTEUR DE FUITE DE TERRE DE CLASSE A.

⚠ CAUTION (CANADIAN INSTALLATIONS ONLY) USE COPPER CONDUCTORS ONLY. USE BONDING CONDUCTOR IN ACCORDANCE WITH THE CANADIAN ELECTRICAL CODE PART I. UTILISEZ DES CONDUCTEURS EN CUIVE UNIQUEMENT. UTILISEZ DES CONDUCTEURS DE MISE À LA MASSE CONFORMEMENT AU CODE CANADIEN DE L'ÉLECTRICITÉ, PARTIE I.

SAVE THESE INSTRUCTIONS

	<p>⚠ DANGER</p> <p>Hot water can be dangerous, especially for infants or children, the elderly, or infirm. There is hot water scald potential if the thermostat is set too high.</p> <p>Water temperatures over 125° F (51° C) can cause severe burns or scalding resulting in death.</p> <p>Hot water can cause first degree burns with exposure for as little as:</p> <ul style="list-style-type: none">3 seconds at 140° F (60° C)20 seconds at 130° F (54° C)8 minutes at 120° F (48° C) <p>Test the temperature of the water before placing a child in the bath or shower.</p> <p>Do not leave a child or an infirm person in the bath unsupervised.</p>
---	--

SECTION 1: GENERAL

Bradford White offers thermostatic, and flow controlled tankless electric water heaters.

KwickShot® thermostatic heaters are designed to accept cold or preheated water and heat it to temperatures suitable for normal domestic usage up to a maximum temperature setpoint of 140°F.

“ML” option models: Factory set to a maximum temperature setpoint of 110°F and are recommended for multi-lavatory handwashing applications – refer to section 3 for supplied aerator details.

“CA” option models: Manufactured for Canadian market and it indicates evaluation and compliance to either Underwriters Laboratories (UL) or Intertek (ETL) under CAN/CSA-C22.2 No. 64/No. 88.

KwickShot® flow-controlled heaters are designed to take in cold water and heat it to temperatures suitable for handwashing and other fixed-flow applications.

NOTICE: KwickShot® tankless electric water heaters are tested @ 125 deg. per Department of Energy (DOE) 10CFR Part 430, Energy Conservation Program for Consumer Products.

To obtain optimum performance and energy savings, the water heater should be located as close as possible to the point-of-use. The unit is supplied with compression rings and nuts suitable for direct coupling to 3/8” copper or PEX™ piping. Do not use additional screwed fittings, pipe dope or Teflon tape – doing so will void the warranty. **DO NOT SOLDER PIPES WHILE THE UNIT IS INSTALLED** as serious damage to the heater will result and the warranty will be voided

SECTION 2: MOUNTING THE UNIT TO THE WALL



THIS HEATER MUST BE INSTALLED IN A LOCATION WHERE IT IS NOT SUBJECT TO FREEZING TEMPERATURES.

The heater should be mounted on the wall under the sink, as close to the point-of-use as possible. Ideal position is fittings pointed down; however, the heater may be mounted in any orientation.

Note: an additional logo decal has been provided to ensure branding is clearly displayed in any mounting orientation.

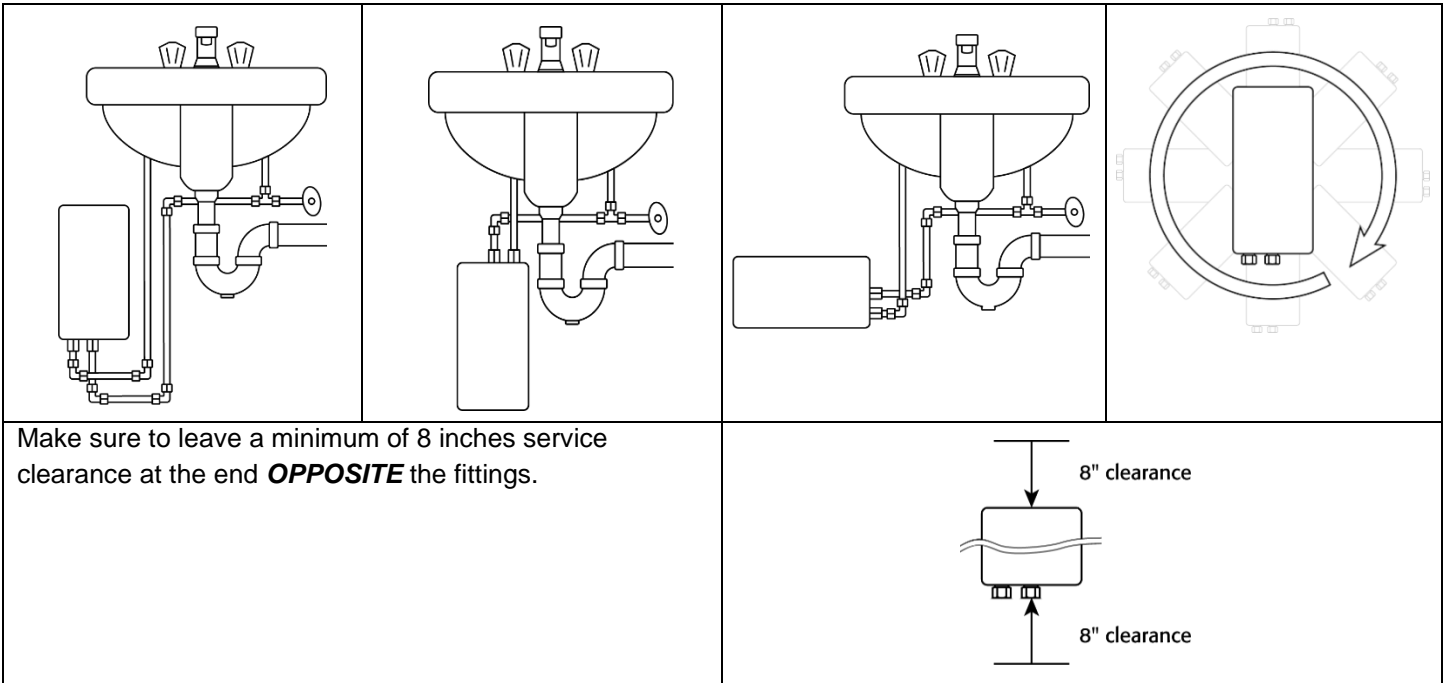

Remove the cover and fasten to the wall using the mounting holes at each corner of the back plate. Replace the cover.

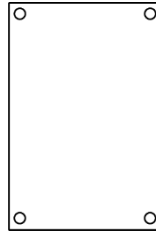

- Minimum turn on flow rates are family dependent:
 - *Thermostatic Models: 0.2 GPM*
 - *Flow Controlled Models: vary by model (refer to the table below)*
- Minimum/maximum working pressure: 30 PSI/150 PSI (Optimal operating pressure range: 35 to 80 PSI)

SECTION 3: PLUMBING HOOK-UP

The water heater is supplied with 3/8" brass compression fittings that are compatible with either copper or plastic pipes. Make sure these fittings are used for this installation. Contact your representative for further information.

CAUTION NEVER SUBSTITUTE THREADED PIPE FITTINGS USING PIPE DOPE OR TEFLON TAPE AND NEVER SOLDER ANY PIPE CONNECTIONS WHILE ATTACHED TO THIS HEATER AS DAMAGE TO THE HEATER WILL RESULT. DOING THIS WILL VOID THE WARRANTY!

Bradford White strongly recommends that the heater be supplied directly from the main cold-water trunk line when possible. This helps to avoid a potential water flow interruption to the water heater which could lead to a failure of the heating element.

System Requirements:

Base Model*	Turn On Flow Rate, GPM (LPM)						
	0.2 (0.76)	0.25 (0.95)	0.3 (1.14)	0.4 (1.51)	0.5 (1.89)	0.7 (2.65)	0.8 (3.03)
TEF024V120		•					
TEF030V120		•					
TEF035V120			•				
TEF035V240			•				
TEF048V240				•			
TEF055V240					•		
TEF065V240						•	
TEF075V240						•	
TEF095V240							•
TEF030V208		•					
TEF041V208				•			
TET083V208						•	
TEF030V277		•					
TEF041V277				•			
TEF060V277						•	
TEF080V277						•	
TEF090V277						•	
TEF100V277							•

*Special suffixed models (i.e. CA, ML), will have identical temperature rises as their base model

For optimum performance, Bradford White recommends the use of isolation valves (full flow ball type) on the inlet and outlet pipes and a 40 mesh Y-Strainer on the inlet of the heater.

Clean the screen periodically for best performance.

 WARNING	BEFORE ATTEMPTING ANY INSTALLATION, MODIFICATION OR SERVICE OF THIS HEATER, MAKE SURE THE ELECTRICAL POWER IS DISCONNECTED.
--	--

The heater's water **INLET** and **OUTLET** are labeled. Install full flow ball valves to the inlet and outlet pipes and run water through the inlet pipe into a bucket to purge it of any debris. Close the inlet ball valve.

*Failure to do so may clog the inlet water screen.



Make sure the inlet filter screen is present in the inlet fitting and the inlet and outlet pipes are correctly aligned with the heater connections to minimize stress on the heater.

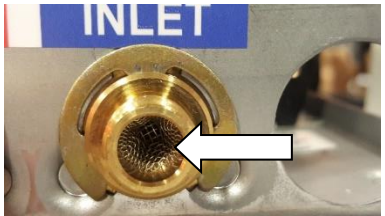

Remove the cover. Connect the pre-assembled inlet and outlet pipes to the heater (**do not overtighten compression fittings**) and fully open the inlet and outlet ball valves. Check the system for water leaks at all plumbing connections. If a leak is present at the compression fitting, **slowly** tighten compression nut until it stops – **do not overtighten**.

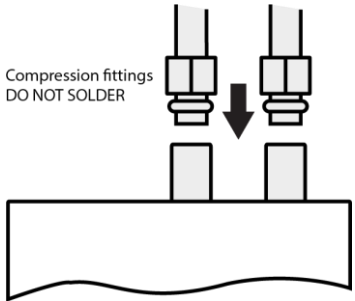

Sample installation diagrams:

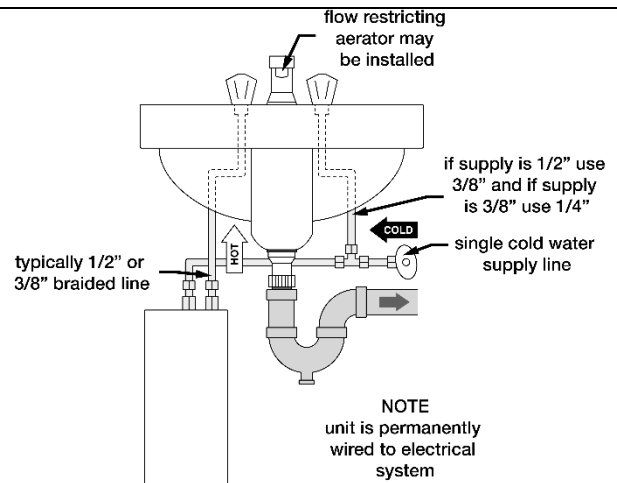
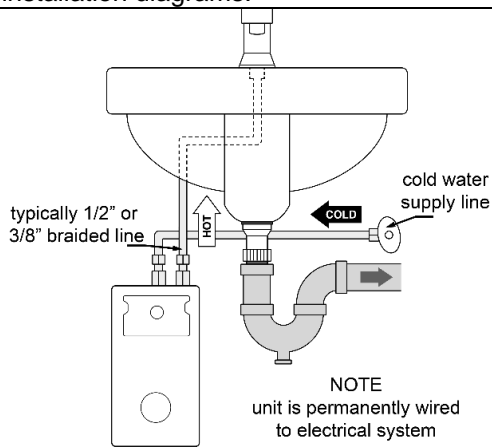

Note: KwickShot® Thermostatic Models only

Open the hot water faucet and run water for a minimum of 60 seconds and until the flow is continuous and free of air pockets. Close the faucet and install the aerator (if supplied).

Failure to install aerator will result in less-than-favorable heater performance.

**ML thermostatic models are designed to deliver a flow of 0.35 GPM to each lavatory. Please install the supplied aerators to ensure maximum heating performance.

MODEL	# OF AERATORS
TET055V240ML	2
TET060V277ML	2
TET065V240ML	2
TET075V240ML	2
TET080V277ML	2
TET083V208ML	3
TET090V277ML	3
TET095V240ML	3
TET100V277ML	3
TET115V240ML	3



SECTION 4: ELECTRICAL HOOK-UP



BEFORE BEGINNING ANY WORK ON THIS INSTALLATION, CONFIRM THE ELECTRICAL BREAKER IS “OFF” AND THAT ALL MOUNTING AND PLUMBING WORK HAS BEEN COMPLETED PER THE STATED INSTRUCTIONS.

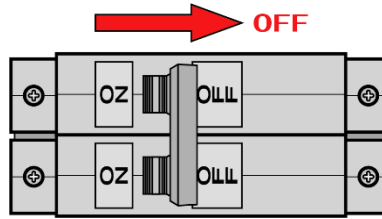

For use on an individual branch circuit only. The heater shall be installed using insulated, UL listed, 2 wire cable (2 wire plus ground) of the appropriate size suitable for up to 75°C and protected by the correctly rated circuit breaker.

Refer to the chart below for recommended copper wiring for conductors with a temperature rating of 75°C:

Flow Controlled Models	Thermostatic Models	Voltage (VAC)	Max power (kW)	Max current (A)	Minimum wire size (AWG) @75°C
TEF024V120	—	120	2.4	20	14
TEF030V120	—	120	3	25	12
TEF035V120	—	120	3.5	29	10
TEF035V240	—	240	3.5	15	14
TEF048V240	—	240	4.8	20	14
TEF055V240	TET055V240	240	5.5	23	12
TEF065V240	TET065V240	240	6.5	27	10
TEF075V240	TET075V240	240	7.5	32	10
TEF095V240	TET095V240	240	9.5	40	8
—	TET115V240	240	11.5	48	8
TEF030V208	—	208	3	15	14
TEF041V208	—	208	4.1	20	14
TEF083V208	TET083V208	208	8.3	40	8
TEF030V277	—	277	3	11	14
TEF041V277	—	277	4.1	14.8	14
TEF060V277	TET060V277	277	6	22	12
TEF080V277	TET080V277	277	8	29	10
TEF090V277	TET090V277	277	9	33	10
TEF100V277	TET100V277	277	10	36	8

*Recommendation for special suffixed models (i.e. CA, ML), are identical to standard models.

Power cable entry to the heater should be made through one of the knock-out holes located on the back plate or top/bottom ends of the unit. Use the appropriate strain relief fitting.

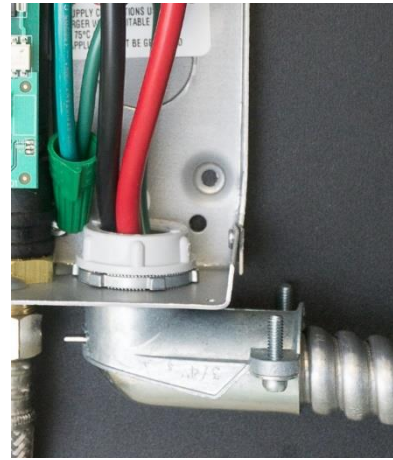

The power leads are to be secured to the L1 and L2 or L and N connectors on the terminal block or relay. The ground lead is to be secured to the GND connector on the block or the green ground wire with the provided wire nut.

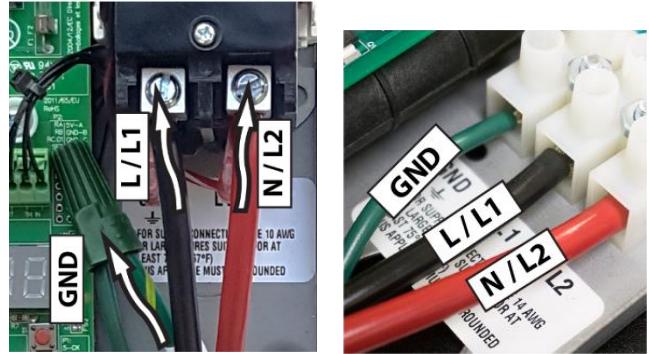

⚠ WARNING

FAILURE TO GROUND THE SYSTEM MAY RESULT IN SERIOUS INJURY, DEATH AND/OR PROPERTY DAMAGE.

Leave the breaker in the “OFF” position. Proceed to the next section:

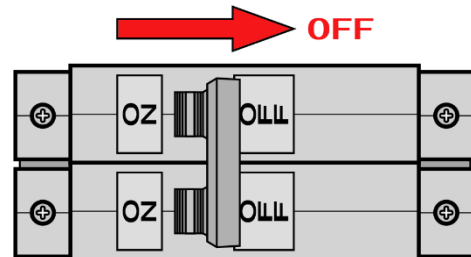

SECTION 5: COMMISSIONING THE HEATER

CAUTION BEFORE SWITCHING THE ELECTRICAL BREAKER “ON”, VERIFY THE INLET AND OUTLET BALL VALVES ARE FULLY OPEN AND WATER IS FLOWING THROUGH THE HOT WATER FAUCET FOR A MINUTE OR TWO UNTIL THE FLOW IS CONTINUOUS AND FREE FROM AIR POCKETS. DO NOT SWITCH THE BREAKER “ON” IF THERE IS A POSSIBILITY THE WATER IN THE HEATER IS FROZEN.

Verify water is flowing through the faucet.

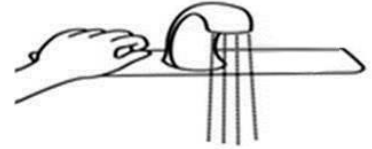

Switch “ON” the electric power supply at the breaker.

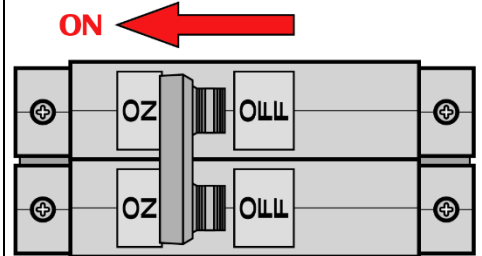

The following steps are dependent on the water heater, please be sure to read all instructions to best commission the appropriate model.

KwickShot® Flow Controlled Models

The LED indicator light will flash rapidly while water flows through the unit. Maintain flow. After 15 seconds, the LED indicator light will turn solid red and there will be an audible click. **The heater is commissioned at this point.** The faucet can be turned off and used as needed.

Note: with no flow, the unit will flash every 4 seconds, indicating normal stand-by mode.



KwickShot® Thermostatic Models

Keep water flowing through the faucet for the next step. The display on the circuit board should come “ON”. With the flow running, the heater will go through the 60 seconds startup/self-calibration procedure. The display will count down from 60 to 0. When the display timer reaches 45, the unit starts heating and continues counting down to 0.



After the 60 seconds in step 4, the display will show the temperature setpoint. See **The heater is commissioned at this point.** Faucet can be turned off and used as needed.



Note: the temperature display will turn off after 5 minutes of inactivity. Display turns on when water flows through heater.

Congratulations!

Your KwickShot® tankless electric water heater is installed and ready for use!

For temperature rise at specified flow rate, please consult the table below:

BASE MODEL* KwickShot® Flow controlled models	FLOW RATE, GPM (LPM)															
	0.2	(0.76)	0.25	(0.95)	0.3	(1.14)	0.4	(1.51)	0.5	(1.89)	0.7	(2.65)	0.8	(3.03)	1	(3.79)
	TEMPERATURE RISE, °F (°C)															
TEF024V120	82	(46)	66	(37)	55	(31)	41	(23)	33	(18)	23	(13)	20	(11)	16	(9)
TEF030V120	-	-	82	(46)	68	(38)	51	(28)	41	(23)	29	(16)	26	(14)	20	(11)
TEF035V120	-	-	-	-	80	(44)	60	(33)	48	(27)	34	(19)	30	(17)	24	(13)
TEF035V240	-	-	-	-	80	(44)	60	(33)	48	(27)	34	(19)	30	(17)	24	(13)
TEF048V240	-	-	-	-	-	-	82	(46)	66	(37)	47	(26)	41	(23)	33	(18)
TEF055V240	-	-	-	-	-	-	-	-	75	(42)	54	(30)	47	(26)	38	(21)
TEF065V240	-	-	-	-	-	-	-	-	-	-	63	(35)	55	(31)	44	(24)
TEF075V240	-	-	-	-	-	-	-	-	-	-	73	(41)	64	(36)	51	(28)
TEF095V240	-	-	-	-	-	-	-	-	-	-	-	-	81	(45)	65	(36)
TEF030V208	-	-	82	(46)	68	(38)	51	(28)	41	(23)	29	(16)	26	(14)	20	(11)
TEF041V208	-	-	-	-	-	-	70	(39)	56	(31)	40	(22)	35	(19)	28	(16)
TEF083V208	-	-	-	-	-	-	-	-	-	-	81	(45)	71	(39)	57	(32)
TEF030V277	-	-	82	(46)	68	(38)	51	(28)	41	(23)	29	(16)	26	(14)	20	(11)
TEF041V277	-	-	-	-	-	-	70	(39)	56	(31)	40	(22)	35	(19)	28	(16)
TEF060V277	-	-	-	-	-	-	-	-	82	(46)	59	(33)	51	(28)	41	(23)
TEF080V277	-	-	-	-	-	-	-	-	-	-	78	(43)	68	(38)	55	(31)
TEF090V277	-	-	-	-	-	-	-	-	-	-	-	-	77	(43)	61	(34)
TEF100V277	-	-	-	-	-	-	-	-	-	-	-	-	-	-	68	(38)

Note: the values shown above are only for comparison purposes.

*Special suffixed models (i.e. CA, ML), will have identical temperature rises as their base model

“-” Flow rate below turn on flow for this model

BASE MODEL* KwickShot® Thermostatic models	FLOW RATE, GPM (LPM)															
	0.35	(1.33)	0.5	(1.89)	1	(3.79)	1.5	(5.68)	2	(7.58)	2.5	(9.48)	3	(11.37)		
	TEMPERATURE RISE, °F (°C)															
TET055V240	107**	(59)	75	(42)	38	(21)	25	(14)	19	(11)	15	(8)	13	(7)		
TET065V240	127**	(71)	89	(49)	44	(24)	30	(17)	22	(12)	18	(10)	15	(8)		
TET075V240	146**	(81)	102**	(57)	51	(28)	34	(19)	26	(14)	20	(11)	17	(9)		
TET095V240	185**	(103)	130**	(72)	65	(36)	43	(24)	32	(18)	26	(14)	22	(12)		
TET115V240	224**	(124)	157**	(87)	79	(44)	52	(29)	39	(22)	31	(17)	26	(14)		
TET083V208	162**	(90)	113**	(63)	57	(32)	38	(21)	28	(16)	23	(13)	19	(11)		
TET060V277	117**	(65)	82	(46)	41	(23)	27	(15)	20	(11)	16	(9)	14	(8)		
TET080V277	156**	(87)	109**	(61)	55	(31)	36	(20)	27	(15)	22	(12)	18	(10)		
TET090V277	176**	(98)	123**	(68)	61	(34)	41	(23)	31	(17)	25	(14)	20	(11)		
TET100V277	195**	(108)	137**	(76)	68	(38)	46	(26)	34	(19)	27	(15)	23	(13)		

**Note: the heaters' actual temperature rises are limited by their thermostatic controls. The theoretical values shown above are only for comparison purposes.

SECTION 6: KwickShot® THERMOSTATIC MODEL OPERATION

Factory temperature setpoints/maximum adjustable range:

KwickShot® Thermostatic models		Default Setpoint (°F)	Minimum Setpoint (°F)	Maximum Setpoint (°F)
Base Model	<4kW	105	70	140
	>4kW	120		
ML (Multi Lavatory)		110	70	110

CHANGING SETPOINT TEMPERATURE

To INCREASE temperature, tap the “+” button repeatedly, or hold the “+” down to INCREASE the temperature quickly. To DECREASE temperature, tap the “-” button repeatedly, or hold the “-” down to DECREASE the temperature quickly.

ADVANCED FUNCTIONS

With the display showing the current setpoint temperature, press BOTH “+” AND “-” buttons simultaneously for 3 seconds.

Screen Info	Title	Units	Description
Flow Rate	FLO	GPM or LPM	Current water flow rate through unit
Inlet temperature	IN	°F or °C	Cold water temperature
Outlet temperature	OUT	°F or °C	Hot water temperature
Power Factor	PF	%	How hard the heater is working
Software Revision	SR	-	For Technical Support assistance

Hold “-” to display the current screen title.

Press “+” to advance to the next screen.

Holding both “+” and “-” at any time for 3 seconds returns the display to the temperature set point, or just let the heater return to set point display on its own after a period of time.

ERROR CODES & UNITS

From Advanced Menu, press and hold the “+” and “-” buttons for 10 seconds.

Screen Info	Title	Description
Current Error(s)	CE	Any errors currently present (F0 displays if no errors are present)
Past Errors	PE	Previous 5 errors and faults
Units	UN	Choose between °F/GPM and °C/LPM
Eco Mode*	ECO	Toggle non-silent operation

* Thermostatic models only

Pressing “-” at any time will display screen title (CE, PE1-5, UN, ECO).

Press the “+” button for 1 second to cycle through the following screens:

To return to setpoint hold “+” and “-” for 10 seconds, or just let the heater return to setpoint display or display turn-off on its own after a period of time.

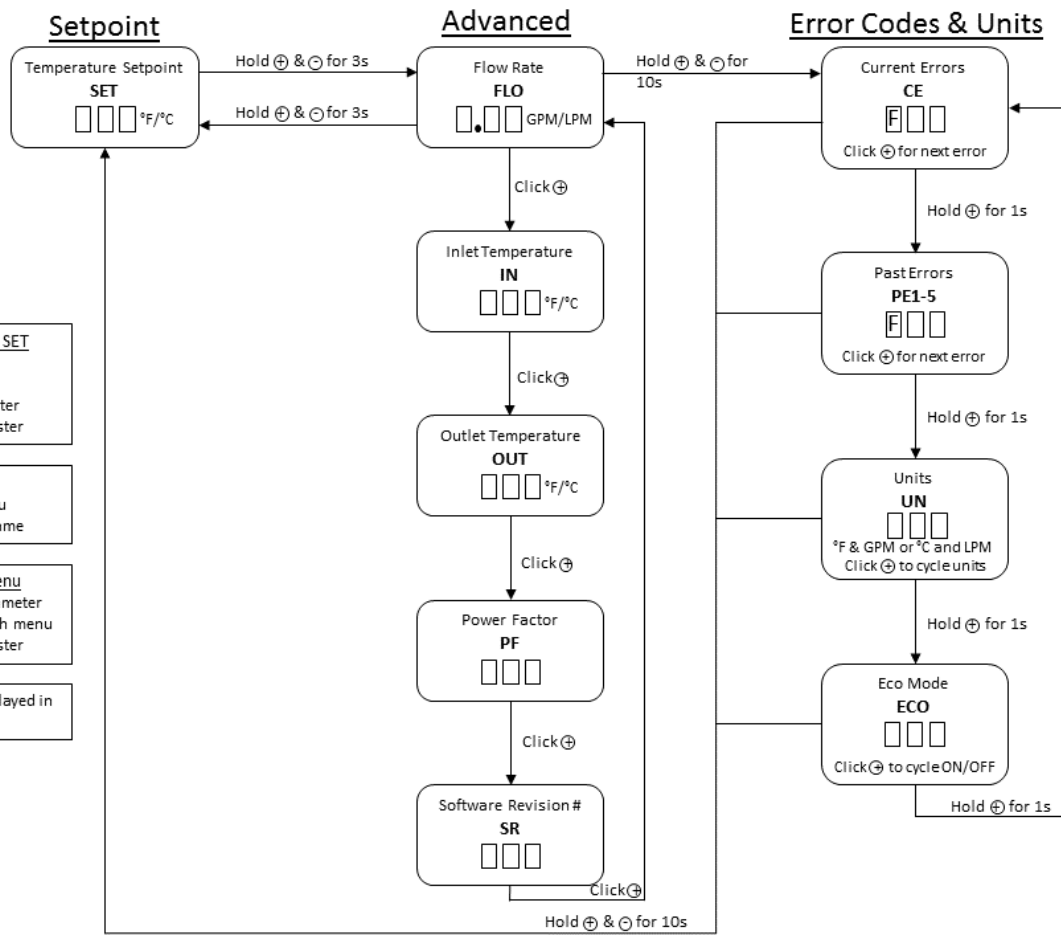

Temperature Setpoint – SET
 Click ⊕ to increase temp.
 Click ⊖ to decrease temp.
 Hold ⊕ to increase temp. faster
 Hold ⊖ to decrease temp. faster

Advanced Menu
 Click ⊕ to cycle through menu
 Hold ⊖ to view parameter name

Error Codes & Units Menu
 Click ⊕ to cycle through parameter
 Hold ⊕ for 1s to cycle through menu
 Hold ⊖ to decrease temp. faster

Temp. and flow rate are displayed in the chosen unit setting

SECTION 7: TROUBLESHOOTING



ENSURE POWER TO THE UNIT IS “OFF” BEFORE REMOVING THE PROTECTIVE COVER FOR ANY REASON.

For status resolution, please consult the table for your heater model below.

KwickShot® Thermostatic models				
Code	Name	Possible causes	Heater response	Possible solutions
F23	No heat	<ul style="list-style-type: none"> - element failure - ECO tripped/malfunctioning - triac(s) failed open - relay/contactor malfunctioning - control board failure - inlet water supply out of spec 	Heating will be disabled after 30 seconds of continuous no heat condition.	- measure element resistance with the unit completely turned off
F24	Low heat	<ul style="list-style-type: none"> - undervoltage - triac(s) failed open - control board failure - inlet/outlet thermistor(s) failure 	Heating enabled, reduced performance (lower outlet temperature).	- verify power supply (voltage) while heater is running
F33	Residual heat	<ul style="list-style-type: none"> - internal water temperature elevated without flow - both triacs failed closed 	Heating disabled until outlet temperature falls below the reactivation temperature (see default parameters table).	- run water through the unit
F34	Overvoltage	- inlet voltage is too high compared to the stated heater specifications	Heating enabled, reduced performance (higher outlet temperature).	<ul style="list-style-type: none"> - have certified personnel verify the inlet voltage - provide voltage within specified range
F36	Undervoltage	- inlet voltage is too low compared to the stated heater specifications	Heating enabled, reduced performance (lower outlet temperature).	<ul style="list-style-type: none"> - have certified personnel verify the inlet voltage - provide voltage within specified range
F38	High flow	- flow is too high to heat the water to setpoint temperature	Heating enabled; unit operates as intended (lower outlet temperature possible).	- reduce flow (outlet flow restrictor, faucet aerator)
F47	Inlet thermistor failure	- inlet thermistor interrupted or disconnected	Heating enabled based on default inlet temperature setting (see default parameters table; higher/lower outlet temperature possible).	- inspect connections/wiring of inlet thermistor
F48	Outlet thermistor failure	- outlet thermistor interrupted or disconnected	Heating enabled; auto calibration disabled.	- inspect connections/wiring of outlet thermistor
F64	Freeze warning	- inlet temperature is too low (below 35°F)	Heating disabled while condition is present.	- increase inlet water temperature above 35°F

KwickShot® Thermostatic models			
Status code	Model suffix	Default values	
F33	T, ML	Trip	170°F
		Reactivation	140°F

KwickShot® Flow controlled models				
LED Pattern	Status/Problem	Possible causes	Heater response	Possible solutions
Solid light	Heating	N/A	N/A	N/A
One flash every four seconds	Idle	N/A	- unit waits for flow	N/A
Two flashes once, three second pause	Low heat	<ul style="list-style-type: none"> - outlet temperature below 90°F/32°C for 5 seconds of flow - element failure - ECO tripped/malfunctioning - relay/contactor malfunctioning - control board failure - inlet water supply out of spec 	- unit keeps running, LED flashes a warning pattern	- reduce flow through unit
Two flashes twice, three second pause	Outlet thermistor failure	- outlet thermistor interrupted or disconnected	- unit keeps running, LED flashes a warning pattern	- inspect connections/wiring of outlet thermistor
Two flashes three times, three second pause	Over-temperature Warning	- outlet temperature exceeds 110°F/38°C	- unit keeps running, LED flashes a warning pattern	-increase flow through unit. If this temperature is desired no action is required
Three flashes once, three second pause	Over-temperature Protection	- outlet temperature exceeds 150°F/65°C	- unit stops heating until outlet temperature falls below preset minimum	- increase flow through unit to decrease the overall temperature rise
Three flashes twice, three second pause	Freeze warning	- inlet temperature is too low (below 35°F/2°C)	- heating disabled	- increase temperature of inlet water to meet product specifications

SECTION 8: PERIODIC MAINTENANCE

The heater is designed for many years of carefree use. In order to maintain consistent water flow, it may be necessary to periodically clean the faucet aerator, or the filter screen located in the brass inlet fitting at the heater.

Element cartridge installs inside heating chamber of all heaters	
--	--

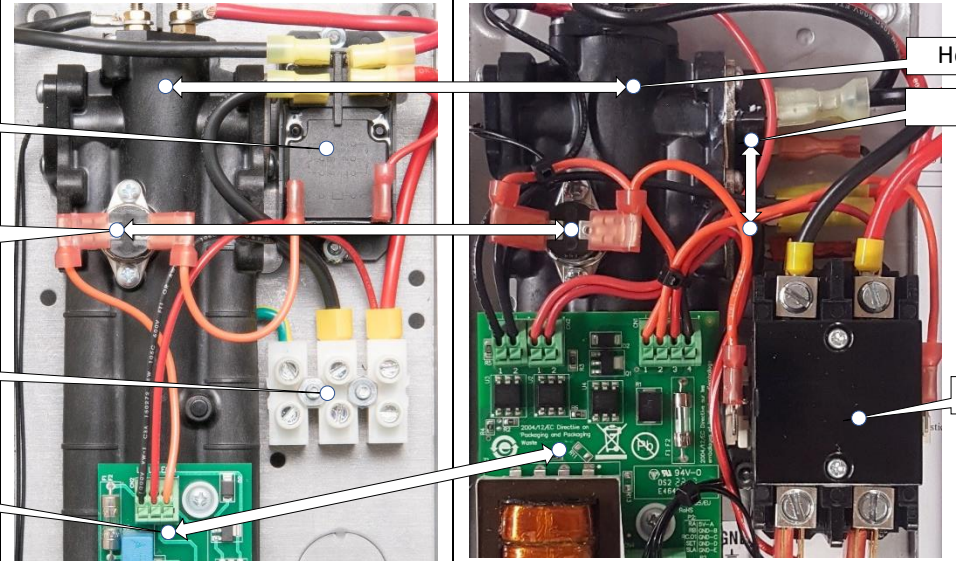
KwickShot® Flow controlled models	KwickShot® Thermostatic models
<div style="display: flex; justify-content: space-between;"> <div style="width: 45%;"> <p>Relay</p> <p>Electrical cut-off (ECO)</p> <p>Terminal block</p> <p>Control board</p> </div> <div style="width: 5%; text-align: center;">  </div> <div style="width: 45%;"> <p>Heating chamber</p> <p>Triacs</p> <p>Contactor</p> </div> </div>	

SECTION 9: REPLACEMENT PART NUMBERS

COMPRESSION FITTINGS	
3/8" NUT	EX68B
3/8" SLEEVE	EX68C
Energy Cut-Off (ECO)	
KwickShot® Thermostatic models (Base, ML)	EX278A-KIT
KwickShot® Flow controlled models (Base)	EX278A-KIT
CA	EX08100-03-KIT

AERATORS	
0.35 GPM	EX0061-0.3-AER
0.5 GPM	EX0061-0.5-AER
PLUMBING ADAPTORS	
MALE 13/16"-27 X MALE 55/64"-27	EX61-339
FEMALE 3/4"-27 X MALE 55/64"-27	EX61-341
FEMALE 13/16"-24 X MALE 55/64"-27	EX61-349
MALE 15/16"-27 X MALE 55/64"-27	EX61-336
MALE 11/16"-27 X MALE 55/64"-27	EX61-344
MALE M24X1/FEMALE M22X1 X MALE 55/64"-27	EX61-387

SECTION 10: REPAIR PARTS

KwickShot® Thermostatic models

KwickShot® Flow controlled models

MODEL NUMBER*	ELEMENT CARTRIDGE	CONTROL BOARD	RELAY
TET055V240	EX1050	EX384-240	EX255B
TET065V240	EX890	EX384-240	EX255B
TET075V240	EX770	EX384-240	EX255B
TET090V240	EX630	EX384-240	EX255B
TET115V240	EX500 PRT	EX384-240	EX1050-1
TET083V208	EX520	EX384-240	EX255B
TET060V277	EX1280	EX384-277	EX253B
TET080V277	EX960	EX384-277	EX253B
TET090V277	EX850	EX384-277	EX253B
TET100V277	EX760	EX384-277	EX253B

MODEL NUMBER*	ELEMENT CARTRIDGE	CONTROL BOARD	RELAY
TEF024V120	EX610	EX383	EX250B
TEF030V120	EX480	EX383	EX250B
TEF035V120	EX410	EX383	EX250B
TEF035V240	EX1650	EX383	EX254
TEF048V240	EX1200	EX383	EX254
TEF055V240	EX1050	EX383	EX254
TEF065V240	EX890	EX383	EX254
TEF075V240	EX770	EX383	EX255B
TEF095V240	EX630	EX383	EX255B
TEF030V208	EX1440	EX383	EX254B
TEF041V208	EX1050	EX383	EX254B
TEF083V208	EX520	EX383	EX255B
TEF030V277	EX260	EX383	EX251B
TEF041V277	EX1870	EX383	EX251B
TEF060V277	EX1280	EX383	EX251B
TEF080V277	EX960	EX383	EX251B
TEF090V277	EX850	EX383	EX253B
TEF100V277	EX760	EX383	EX253B

*Special suffixed models (i.e. CA, ML), will have identical replacement parts as their base model.

If you need any assistance from our Technical Service Department, make sure you can identify this water heater by having the following numbers from your unit:

Model Number: _____

Serial Number: _____

Bradford White Corporation

200 Lafayette Street
 Middleville, MI 49333
 800-334-3393