

MONARCH 6036

60" x 36" x 20"

Monarch is a refined collection of therapeutic baths with distinctive deck surfaces, for a look that's noble and pure. The Collection offers luxurious bathtubs: the Monarch Grand Luxury models, featuring splendid One-piece Quartz deck.







PRODUCT NO.





| DESCRIPTION | TMU | TUB |
|--------------------|--------------|--------------|
| Standard (S)* | BMOFRB00T-XX | BMOFRB00N-XX |
| Grand Luxury (GL)* | BMLFRB00T-XX | BMLFRB00N-XX |

| THERMOMASSEUR (TMU) Hydro-thermo massage + Air jet system | S \$ | GL \$ |
|--|------|----------|
| Jets | | 40 |
| 1 heated backrest | | Included |
| MiaPlus® Control (not installed) | | Included |
| Geysair® | | Included |
| AromaCloud® | | N/A |
| Illuzio Chromatherapy BCHRO6 | | \$ |

| TUB Soaker | S \$ | GL \$ |
|------------------------------|------|-----------------------|
| AromaCloud® | | N/A |
| Illuzio Chromatherapy BCHRO6 | | \$ |
| WarmTouchShell® BWTS | | \$ |
| DOT control | | Included with therapy |

| FEATURES | | | |
|---|--|---|--|
| Installation type | | Drop-in & Alcove (3 walls) | |
| No. of bathers | Imp. gallons | 40 | |
| US gallons | 48 | | |
| INTEGRATED WASTE & OVERFLOW BOVERINI-XX | | | |
| White 01, Chrome 07, Brushed Nickel 09, Polished Nickel 10 | | Inst. & Incl. | |
| STANDARD COLOR (inner shell) | | | |
|  White 01 | | Included | |
| QUARTZ DECK COLOR | | S* | GL* |
| | | BDMO6036-XX | BDML6036-XX |
|  Grey Expo 21 |  Noka 22 |  Jet Black 23 |  Lagos Blue 24 |
| | | Included | Included |

OPTIONS (UPCHARGE APPLICABLE)

| QUARTZ DECK COLOR | S* | GL* |
|--|----|-----|
|  Quasar Light 25 | \$ | \$ |
|    Piatra Grey 26, Bianco Drift 31, Woodlands 30 | \$ | \$ |
|  Statuario Maximus 29 | \$ | \$ |
| FINISH (inner shell) | | |
| UltraVelour Matte Finish (White only) BVEL | | \$ |
| INTEGRATED WASTE & OVERFLOW BOVERINI-XX | | |
| Matte Black 19, Black Chrome 12, Satin Brass 18 | | \$ |
| WASTE & OVERFLOW 16" x 35" BOVER16-XX | | |
| Chrome 07 | | \$ |
| White 01 | | \$ |
| Brushed Nickel 09, Polished Nickel 10, Oil-rubbed Bronze 11 | | \$ |
| QUARTZ SKIRT 6018 (60" x 18 7/8") BSM6018-XX | | |
| Grey Expo 21, Noka 22 | | \$ |
| Jet Black 23, Lagos Blue 24 | | \$ |
| Quasar Light 25 | | \$ |
| Piatra Grey 26, Bianco Drift 31, Woodlands 30 | | \$ |
| Statuario Maximus 29 | | \$ |
| CONTROL (TMU only) | | |
| MiaMulti® BMIAM2-XX | | \$ |
| TILE FLANGE (specify right or left) | | |
| Ordered with bath (not installed) BTILEN | | \$ |
| Factory-installed. Right BTILER, Left BTILEL, Special installation BTILEO | | \$ |
| IF REQUIRED BY CONSTRUCTION CODE OR INSTALLED WITH ITD | | |
| Brass waste & overflow kit** BDRCOB | | \$ |
| Brass waste kit** BDRCB | | \$ |
| 16" x 35" Cable driven Brass waste & overflow kit BOVERBR-XX | | \$ |



MONARCH 6036



Bianco Drift quartz deck

INSTALLATION

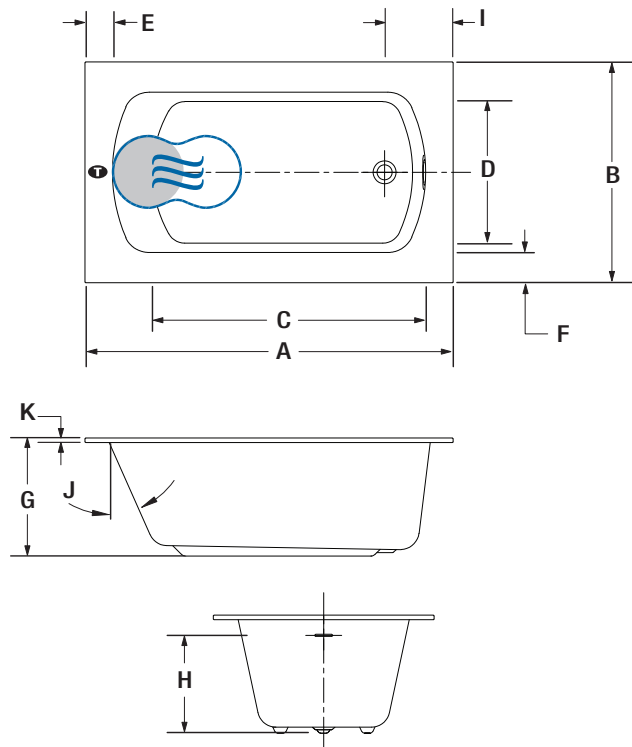

| LETTER | DESCRIPTION | MEASURE |
|--------|---|---------|
| A | Total length | 60" |
| B | Total width | 36" |
| C | Bathing well length (at height of jets) | 42 3/8" |
| D | Bathing well width (at height of jets) | 22 3/4" |
| E | Deck width (edges) | 4 5/8" |
| F | Deck width (sides) | 5 1/8" |
| G | TUB height | 19 7/8" |
| H | Height from waste to center of overflow | 15 3/8" |
| I | Outside edge to center waste | 11 1/8" |
| J | Slope of backrest | 24° |
| K | Quartz deck height | 3/4" |

- T** Turbine position (TMU)
- Indicates WarmTouchShell® position (TUB)
- Indicates heated backrest (TMU)

Don't forget that this model is available in **White only with choice of deck color**. Don't forget to specify the **finish of the integrated waste & overflow**.

* Standard: Quartz deck with seam. Grand Luxury: one piece Quartz deck.
 ** When ordered with integrated waste & overflow.

TOTAL PRICE \$

TECHNICAL SPECIFICATIONS

| | |
|----------------------------------|---|
| Hot water supply required | Should be 70% of water capacity of TUB or greater. |
| Turbine | Access to the pump must be at least 18" x 22". Standard connection is 20 A, 120 V, 60 hz , dedicated line with a Ground-Fault Circuit Interrupter (GFCI). For any additional option, a second line is needed 15 A, 120 V, 60 hz , dedicated line with a GFCI. |
| Other | Control cannot be installed on the Quartz deck. |

Our products must be installed by certified professionals only and according to our Monarch Installation Manual as well as federal, provincial/state and local building codes and regulations (www.bainultra.com/documentation/documentation).

| | |
|--------------------------------|----------|
| Approx. shipping weight | 244 lbs |
| Turbine power | 550 W |
| Air heater | 600 W |
| WARRANTY | |
| Controls-LED-Geysair* | 5 years |
| Quartz deck* | 15 years |
| Bath & turbine* | 20 years |

* Some restrictions apply | www.bainultra.com/warranty



The specifications shown indicate the outer edge dimension and the inside bathing capacity dimension measured at air jets' height. The manufacturer accepts a 1/4" [0.64 cm] variance. There are variations on each product and specifications are subject to change as we improve upon our product as required. The dimensions needed for site preparation and structure building will differ. BainUltra® assumes no responsibility for preparatory work done prior to the product being on site.